

FITTINGS FOR SOCKET WELDING



ISO-BSP adaptor fittings



FITTINGS FOR SOCKET WELDING

Series of fittings designed for conveying fluids under pressure with a hot thread and weld connection system (socket welding).

ISO-BSP ADAPTOR FITTINGS

Technical specifications	
Size range	d 20 ÷ 63 (mm); R 3/8" ÷ 2"
Nominal pressure	PN 10 with water at 20° C
Temperature range	0 °C ÷ 95 °C
Coupling standards	Welding: EN ISO 15494. Can be coupled to pipes according to EN ISO 15494 Thread: ISO 228-1, EN 10226-1/2
Reference standards	Construction criteria: EN ISO 15494 Test methods and requirements: EN ISO 15494 Installation criteria: DVS 2202-1, DVS 2207-11, DVS 2208-1, UNI 11318
Fitting material	PP-H
Seal material	EPDM, FKM

TECHNICAL DATA

PRESSURE VARIATION ACCORDING TO TEMPERATURE

Graph valid for water and non-hazardous fluids with regard to which the material is classified as CHEMICALLY RESISTANT. In other cases, a reduction of the nominal pressure PN is required.

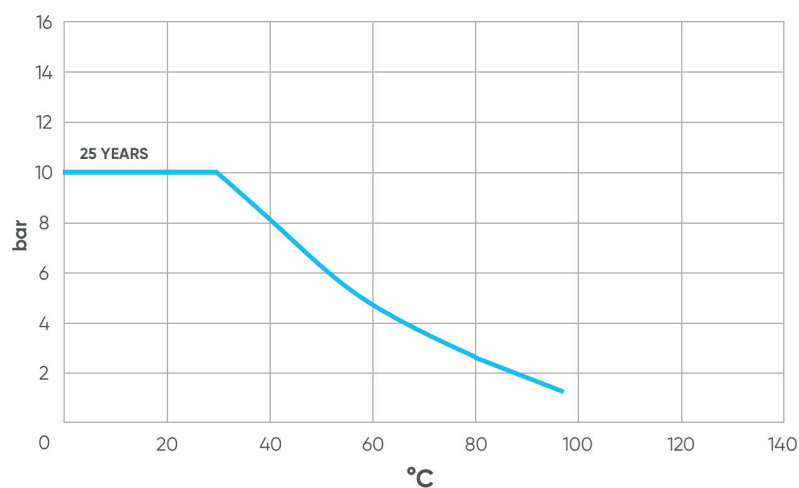

The information in this leaflet is provided in good faith. No liability will be accepted concerning technical data that is not directly covered by recognised international standards. FIP reserves the right to carry out any modification. Products must be installed and maintained by qualified personnel.

DIMENSIONS

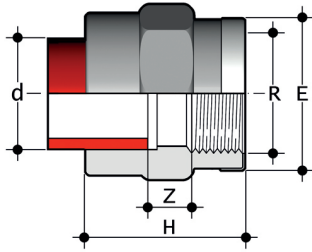

MIMM

Double socket for socket welding (d) and with female BSP thread (R), with STAINLESS steel reinforcing ring

d x R	PN	E	H	Z	g	Code
20 x 1/2"	10	30	39	8	14	MIMM020012
25 x 3/4"	10	39	41	8	23	MIMM025034
32 x 1"	10	47	45	7	40	MIMM032100
40 x 1 1/4"	10	55	50	8	46	MIMM040114
50 x 1 1/2"	10	66	55	9	92	MIMM050112
63 x 2"	10	83	63	9	150	MIMM063200

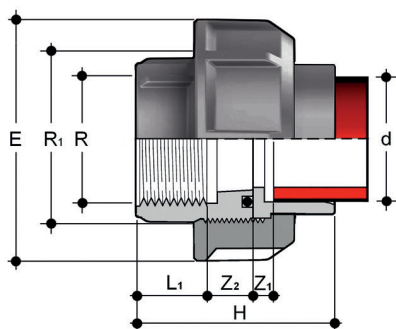

BIFGM

Union for socket welding (d), BSP (R) threaded female end with O-Ring in EPDM or FKM.

d x R	R ₁	PN	E	H	L ₁	Z ₁	Z ₂	g	EPDM code	FKM code
20 x 1/2"	1"	10	47	50,5	15	5,5	16	43	BIFGM020012E	BIFGM020012F
25 x 3/4"	1 1/4"	10	58	54,5	16,3	5,5	16,7	68	BIFGM025034E	BIFGM025034F
32 x 1"	1 1/2"	10	65	59,5	19,1	5,5	16,9	94	BIFGM032100E	BIFGM032100F
40 x 1 1/4"	2"	10	78	66,5	21,4	5,5	19,6	145	BIFGM040114E	BIFGM040114F
50 x 1 1/2"	2 1/4"	10	85	73,5	21,4	5,5	23,6	196	BIFGM050112E	BIFGM050112F
63 x 2"	2 3/4"	10	103	82,5	25,7	5,5	24,3	312	BIFGM063200E	BIFGM063200F

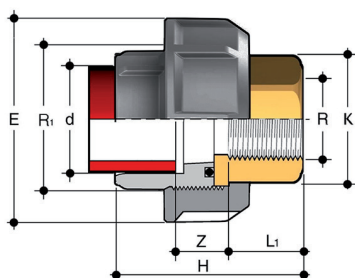

BIFOM

Adaptor union in PP-H/brass for socket welding (d), BSP (R) threaded brass female end with O-Ring in EPDM

d x R	R ₁	PN	E	H	K	L ₁	Z	g	EPDM code
20 x 1/2"	1"	10	47	48,5	25	16,5	18	89	BIFOM020012E
25 x 3/4"	1 1/4"	10	58	53,5	32	18,5	19	159	BIFOM025034E
32 x 1"	1 1/2"	10	65	57,5	38	19,5	20	180	BIFOM032100E
40 x 1 1/4"	2"	10	78	64,5	48	21,5	23	357	BIFOM040114E
50 x 1 1/2"	2 1/4"	10	85	78,5	55	23	32,5	448	BIFOM050112E
63 x 2"	2 3/4"	10	103	85,5	69	27	31,5	785	BIFOM063200E

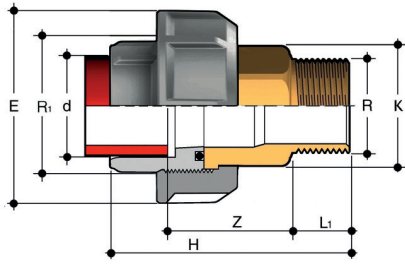

BIROM

Adaptor union in PP-H/brass for socket welding (d), BSP threaded brass male end R with O-Ring in EPDM

d x R	R _i	PN	E	H	K	L ₁	Z	g	EPDM code
20 x 1/2"	1"	10	47	65	25	13,5	37,5	134	BIROM020012E
25 x 3/4"	1 1/4"	10	58	71,5	32	15	40,5	227	BIROM025034E
32 x 1"	1 1/2"	10	65	78	38	17,5	42,5	287	BIROM032100E
40 x 1 1/4"	2"	10	78	87	48	19,5	47,5	534	BIROM040114E
50 x 1 1/2"	2 1/4"	10	85	95	55	19,5	52,5	668	BIROM050112E
63 x 2"	2 3/4"	10	103	113,5	69	24	62,5	1144	BIROM063200E

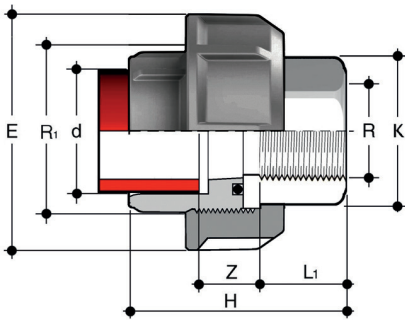

BIFXM

Adaptor union in PP-H/STAINLESS steel for socket welding (d), BSP (R) threaded A316L STAINLESS steel female end with O-Ring in EPDM or FKM

d x R	R _i	PN	E	H	K	L ₁	Z	g	EPDM code	FKM code
20 x 1/2"	1"	10	47	48,5	25	16,5	18	82	BIFXM020012E	BIFXM020012F
25 x 3/4"	1 1/4"	10	58	53,5	32	18,5	19	146	BIFXM025034E	BIFXM025034F
32 x 1"	1 1/2"	10	65	57,5	38	19,5	20	165	BIFXM032100E	BIFXM032100F
40 x 1 1/4"	2"	10	78	64,5	48	21,5	23	328	BIFXM040114E	BIFXM040114F
50 x 1 1/2"	2 1/4"	10	85	78,5	55	23	32,5	411	BIFXM050112E	BIFXM050112F
63 x 2"	2 3/4"	10	103	85,5	69	27	31,5	720	BIFXM063200E	BIFXM063200F

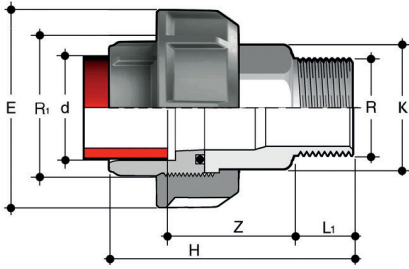

BIRXM

Adaptor union in PP-H/STAINLESS steel for socket welding (d), BSP (R) threaded A316L STAINLESS steel male end with O-Ring in EPDM or FKM

d x R	R ₁	PN	E	H	K	L ₁	Z	g	EPDM code	FKM code
20 x 1/2"	1"	10	47	65	25	13,5	37,5	123	BIRXM020012E	BIRXM020012F
25 x 3/4"	1 1/4"	10	58	71,5	32	15	40,5	208	BIRXM025034E	BIRXM025034F
32 x 1"	1 1/2"	10	65	78	38	17,5	42,5	263	BIRXM032100E	BIRXM032100F
40 x 1 1/4"	2"	10	78	87	48	19,5	47,5	490	BIRXM040114E	BIRXM040114F
50 x 1 1/2"	2 1/4"	10	85	95	55	19,5	52,5	613	BIRXM050112E	BIRXM050112F
63 x 2"	2 3/4"	10	103	113,5	69	24	62,5	1050	BIRXM063200E	BIRXM063200F

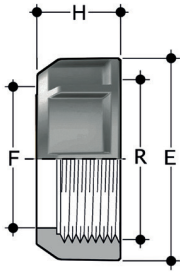

EFGM

Union nut with BSP thread for union types BIGM, BIFGM, BIFOM, BIROM, BIFXM, BIRXM

R	d BIGM	PN	E	F	H	g	Code
1"	20	10	47	28	22	19	EFGM100
1 1/4"	25	10	58	36	25	29	EFGM114
1 1/2"	32	10	65	42	27	40	EFGM112
2"	40	10	78	53	30	57	EFGM200
2 1/4"	50	10	85	59	33	74	EFGM214
2 3/4"	63	10	103	74	38	119	EFGM234

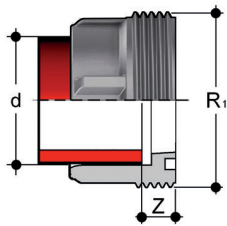

F/BIGM

Union bush for socket welding, metric series

d	R ₁	PN	Z	g	Code
20	1"	10	12	10	FBIGM020
25	1 1/4"	10	12	17	FBIGM025
32	1 1/2"	10	12	24	FBIGM032
40	2"	10	14	39	FBIGM040
50	2 1/4"	10	16	47	FBIGM050
63	2 3/4"	10	18	89	FBIGM063

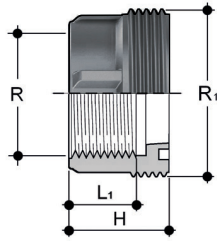

F/BFGM

Union bush with BSP female thread

R	R ₁	PN	H	L ₁	g	Code
1/2"	1"	10	31	15	15	FBFGM012
3/4"	1 1/4"	10	33	16,3	21	FBFGM034
1"	1 1/2"	10	36	19,1	35	FBFGM100
1 1/4"	2"	10	41	21,4	55	FBFGM114
1 1/2"	2 1/4"	10	45	21,4	75	FBFGM112
2"	2 3/4"	10	50	25,7	105	FBFGM200

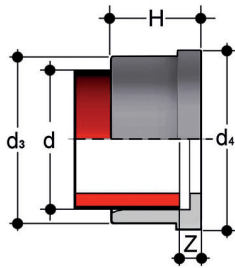

Q/BIGM

Union end for socket welding, metric series

d	PN	d ₃	d ₄	H	Z	g	Code
20	10	27,5	30,1	19,5	5,5	7	QBIGM020
25	10	36	38,8	21,5	5,5	14	QBIGM025
32	10	41,5	44,7	23,5	5,5	17	QBIGM032
40	10	53	56,5	25,5	5,5	30	QBIGM040
50	10	59	62,6	28,5	5,5	30	QBIGM050
63	10	74	78,4	32,5	5,5	51	QBIGM063

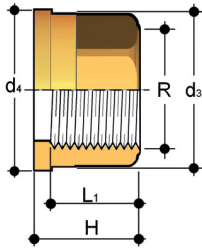

Q/BFO

Union end in brass with BSP female thread

R	d ₃	d ₄	H	L ₁	g	Code
3/8"	22	24	21,5	13,5	38	QBFO038
1/2"	27,5	30,1	22,5	16,5	60	QBFO012
3/4"	36	38,8	25,5	18,5	116	QBFO034
1"	41,5	44,7	27,5	19,5	144	QBFO100
1 1/4"	53	56,5	30,5	21,5	260	QBFO114
1 1/2"	59	62,6	33,5	23	325	QBFO112
2"	74	78,4	38,5	27	578	QBFO200

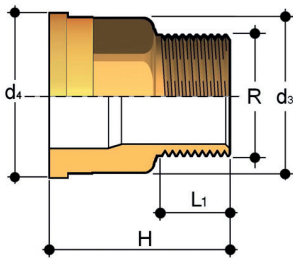

Q/BRO

Union end in brass with BSP male thread

R	d ₃	d ₄	H	L ₁	g	Code
3/8"	22	24	34,5	10,5	64	QBRO038
1/2"	27,5	30,1	39	13,5	105	QBRO012
3/4"	36	38,8	43,5	15	184	QBRO034
1"	41,5	44,7	48	17,5	251	QBRO100
1 1/4"	53	56,5	53	19,5	437	QBRO114
1 1/2"	59	62,6	56	19,5	545	QBRO112
2"	74	78,4	65,5	24	937	QBRO200

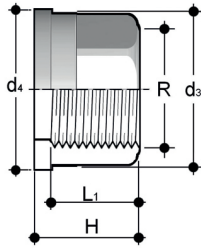

Q/BFX

Union end in A316L STAINLESS steel with female BSP thread

R	d ₂	d ₃	H	L ₁	g	Code
3/8"	22	24	21,5	13,5	34	QBFX038
1/2"	27,5	30,1	22,5	16,5	54	QBFX012
3/4"	36	38,8	25,5	18,5	104	QBFX034
1"	41,5	44,7	27,5	19,5	130	QBFX100
1 1/4"	53	56,5	30,5	21,5	234	QBFX114
1 1/2"	59	62,6	33,5	23	293	QBFX112
2"	74	78,4	38,5	27	520	QBFX200

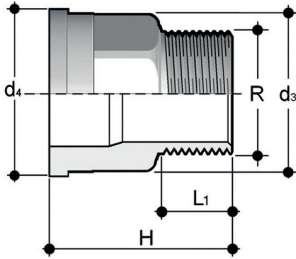

Q/BRX

Union end in A316L STAINLESS steel with male BSP thread

R	d ₂	d ₃	H	L ₁	g	Code
3/8"	22	24	34,5	10,5	58	QBRX038
1/2"	27,5	30,1	39	13,5	95	QBRX012
3/4"	36	38,8	43,5	15	166	QBRX034
1"	41,5	44,7	48	17,5	226	QBRX100
1 1/4"	53	56,5	53	19,5	393	QBRX114
1 1/2"	59	62,6	56	19,5	491	QBRX112
2"	74	78,4	65,5	24	843	QBRX200

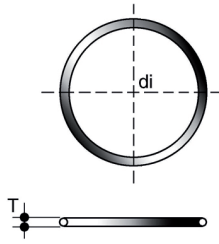

O-RING

Seals for union types BIGM, BIFGM, BIFOM, BIROM, BIFXM, BIRXM

d union	C	di	T	EPDM code	FKM code
16	3062	15,54	2,62	OR3062E	OR3062F
20	4081	20,22	3,53	OR4081E	OR4081F
25	4112	28,17	3,53	OR4112E	OR4112F
32	4131	32,93	3,53	OR4131E	OR4131F
40	6162	40,65	5,34	OR6162E	OR6162F
50	6187	47	5,34	OR6187E	OR6187F
63	6237	59,69	5,34	OR6237E	OR6237F
75	6300	75,57	5,34	OR6300E	OR6300F
90	6362	91,45	5,34	OR6362E	OR6362F
110	6450	113,67	5,34	OR6450E	OR6450F